

SILICON BRIDGE RECTIFIERS

REVERSE VOLTAGE - **50 to 1000**Volts
FORWARD CURRENT - **10.0** Amperes

FEATURES

- Surge overload rating -240 amperes peak
- Ideal for printed circuit board
- Reliable low cost construction utilizing molded plastic technique
- Plastic material has U/L flammability classification 94V-0
- Mounting position: Any

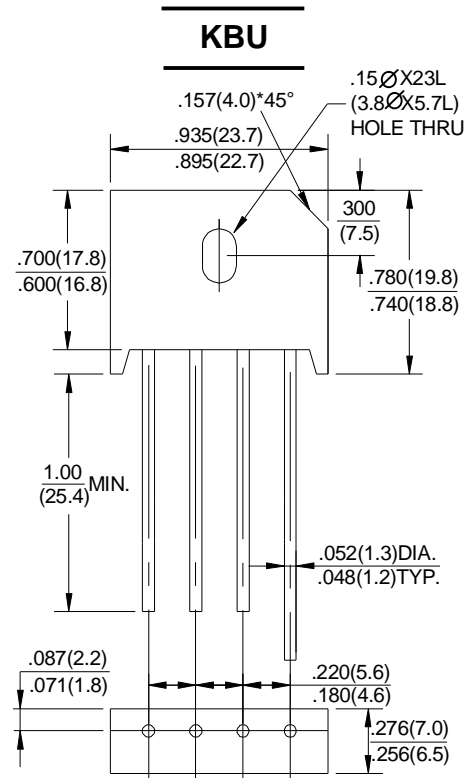

Dimensions in inches and (millimeters)

MAXIMUM RATINGS AND ELECTRICAL CHARACTERISTICS

Rating at 25°C ambient temperature unless otherwise specified.

Single phase, half wave, 60Hz, resistive or inductive load.

For capacitive load, derate current by 20%

CHARACTERISTICS	SYMBOL	KBU 10005	KBU 1001	KBU 1002	KBU 1004	KBU 1006	KBU 1008	KBU 1010	UNIT
Maximum Recurrent Peak Reverse Voltage	V _{RRM}	50	100	200	400	600	800	1000	V
Maximum RMS Voltage	V _{RMS}	35	70	140	280	420	560	700	V
Maximum DC Blocking Voltage	V _{DC}	50	100	200	400	600	800	1000	V
Maximum Average Forward (with heatsink Note 1) Rectified Current @ T _c =100°C (without heatsink)	I _(AV)	10.0 3.0							A
Peak Forward Surge Current 8.3ms Single Half Sine-Wave Super Imposed on Rated Load (JEDEC Method)	I _{FSM}	240							A
Maximum Forward Voltage at 5.0A DC	V _F	1.0							V
Maximum DC Reverse Current @ T _J =25°C at Rated DC Blocking Voltage @ T _J =125°C	I _R	10 500							μA
Operating Temperature Range	T _J	-55 to +150							°C
Storage Temperature Range	T _{STG}	-55 to +150							°C

NOTES: 1. Device mounted on 100mm*100mm*1.6mm Cu plate heatsink.

FIG.1-MAXIMUM FORWARD SURGE CURRENT

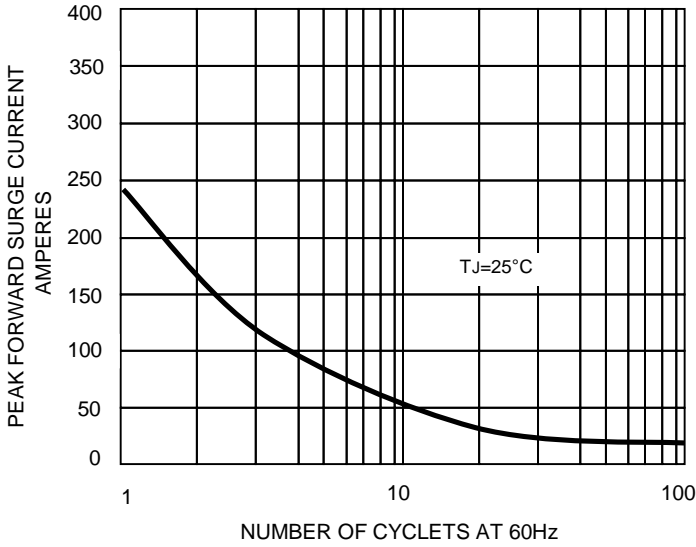

FIG. 2 – DERATING CURVE OUTPUT RECTIFIED CURRENT

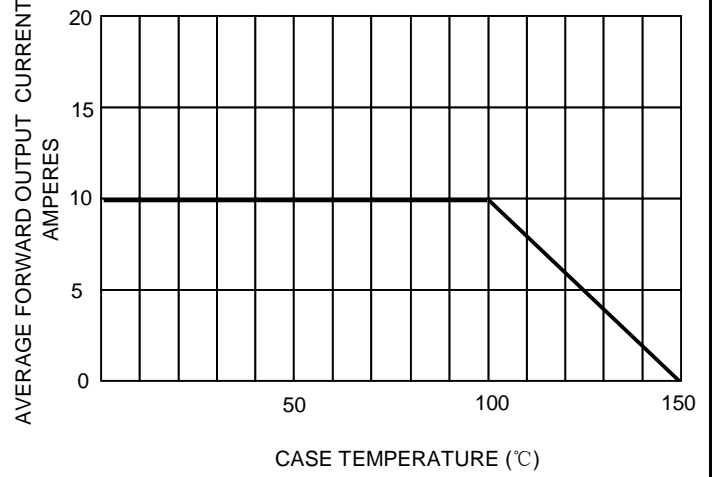

FIG.3- TYPICAL FORWARD CHARACTERISTICS

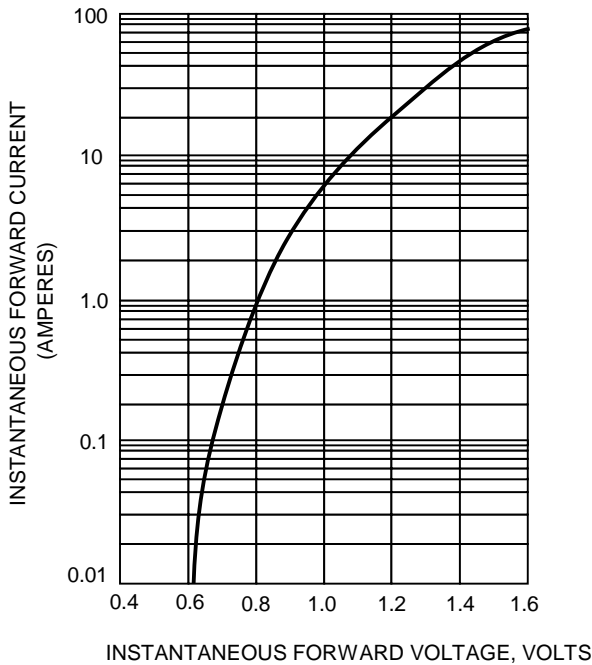

FIG.4- TYPICAL REVERSE CHARACTERISTICS

